

Mental Calisthenics

(19)

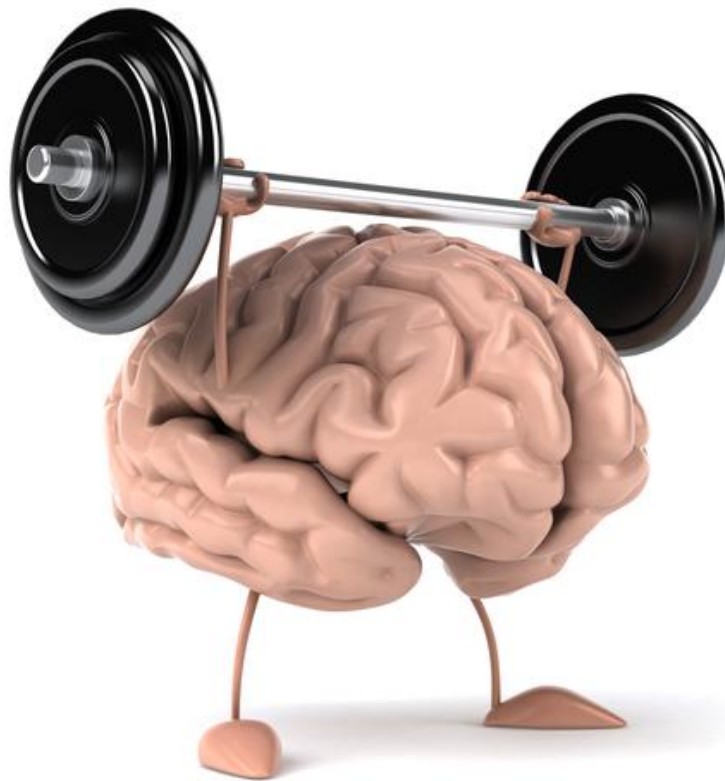

Patient's Name:

Date:

Passing of Time

Ryan is touring San Francisco with his family. They want to visit the Golden Gate Bridge, Alcatraz, and Chinatown before their dinner reservations at 7:45 P.M. They want to spend 1 hour and 45 minutes at the Golden Gate Bridge, 2 hours on the tour of Alcatraz, and 45 minutes in Chinatown. What is the latest time Ryan's family can start their tour of San Francisco and still make it to dinner on time?

Include *A.M.* or *P.M.* in your answer (for example, *11:58 A.M.*).















Wendy is going on a backpacking trip with her family. They need to hike to their favorite camping spot and set up the camp before it gets dark. Sunset is at 7:15 P.M. It will take 3 hours and 15 minutes to hike to the camping spot and 30 minutes to set up the camp. What is the latest time Wendy and her family can start hiking?

Include *A.M.* or *P.M.* in your answer (for example, *11:58 A.M.*).

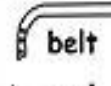
Find the Hidden Objects



Can you find in the picture the objects listed on the right?

- CLUES**
-  book
 -  flashlight
 -  tooth
 -  hand
 -  tent
 -  turkey
 -  paperclip
 -  cane
 -  loaf of bread
 -  paintbrush
 -  belt
 -  canoe
 -  cake slice
 -  dog
 -  bell
 -  glasses

Categorical Fluency



There are many different breeds of dogs. List as many breeds as you can.

Bird House Builder

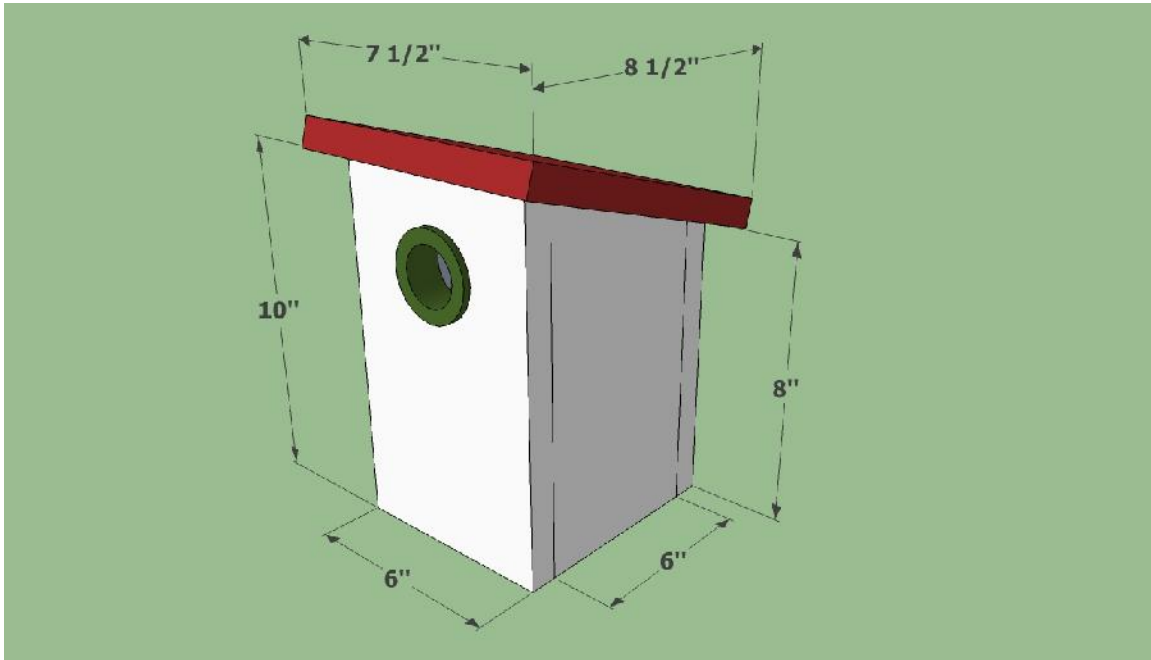

You are planning on building four of the bird houses shown above. How much wood do you need to build one house? To build four houses how much wood do you need?

Copy the Design

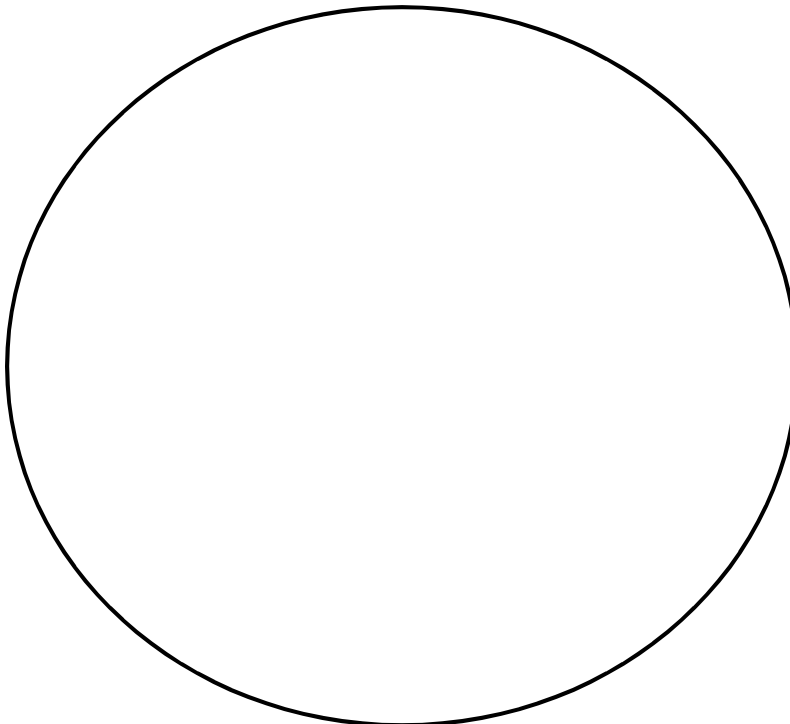
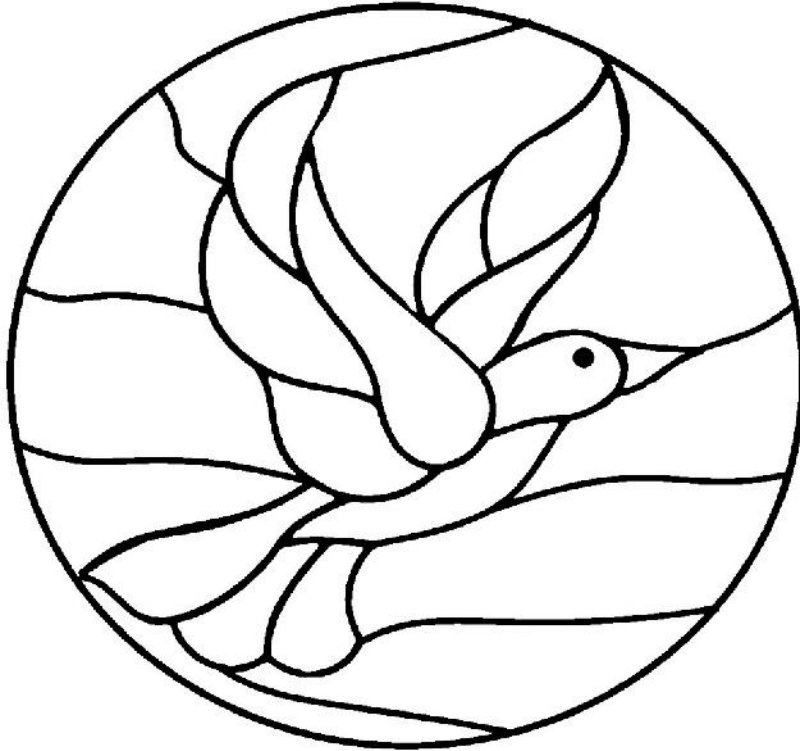

Grocery Shopping

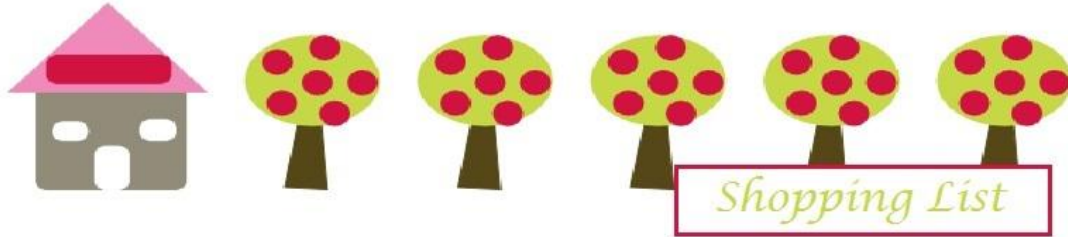

<i>Produce</i> _____ _____ _____ _____ _____	<i>Canned Goods</i> _____ _____ _____ _____ _____	<i>Condiments</i> _____ _____ _____ _____ _____	<i>Pasta & Rice</i> _____ _____ _____ _____
<i>Dairy</i> _____ _____ _____ _____ _____	<i>Meats</i> _____ _____ _____ _____ _____	<i>Frozen Foods</i> _____ _____ _____ _____ _____	<i>Breads</i> _____ _____ _____ _____
<i>Baking</i> _____ _____ _____ _____ _____ _____ _____ _____ _____	<i>Household</i> _____ _____ _____ _____ _____ _____ _____ _____ _____	<i>Health & Beauty</i> _____ _____ _____ _____ _____ _____ _____ _____ _____	<i>Drinks</i> _____ _____ _____ _____ _____
			<i>Breakfast</i> _____ _____ _____ _____ _____
			<i>Pets</i> _____ _____ _____ _____

Shopping List

Write the shopping items in the correct category on the list from the previous page.

Coffee creamer	Flour	Sauerkraut	Oatmeal
Dog treats	Hot dog buns	Pickles	Cabbage
Pepsi	Windex	Pork roast	Mustard
Wheat bread	Yogurt	Celery	Tomato paste
Bleach	Baking powder	Pizza	Sprite
Kitty litter	Macaroni	Apples	Wild rice
Chicken wings	Cereal	Ketchup	Eggnog
Brown sugar	Tater tots	Toothpaste	Dinner rolls
Dental floss	Root beer	French fries	Relish
Canned beans	Cauliflower	Spaghetti	Molasses
Cream of wheat	Spam	Pork ribs	Ginger ale
Soap	Olives	Shampoo	Apricots
Cat nip	Ribeyes	Penne	Soda water
Ice cream	Yeast	Asparagus	Comet cleaner
Band aids	Butter	Jasmine rice	Baking soda
Canned tuna	Eggs	Tangerines	Skirt steak

Rhyme Time

Write down as many words that rhyme with the following:

Kite

Smile

Ball

Cat

Cry

Hit

Pail

Bear

Hook

Dot Painting

The Australian aborigines had many different art forms. One art form was dot painting. Dot painting consists of various paint colors like yellow (representing the sun), brown (the soil), red (desert sand) and white (the clouds and the sky). These are traditional Aboriginal colors. Dot paintings can be painted on anything though in aboriginal times they were painted on rocks, in caves, etc. The paintings were mostly images of animals or lakes, and the dreamtime. Stories and legends were depicted on caves and rocks to represent the artists' religion.

Create your own dot painting below:

